

3SK309

GaAs N Channel Dual Gate MES FET
UHF RF Amplifier

HITACHI

ADE-208-472 A
2nd. Edition

Features

- Capable of low voltage operation ($V_{DS} = 1.5$ to 3 V)
- Excellent low noise characteristics (NF = 1.25 dB typ. at $f = 900$ MHz)
- High power gain (PG = 21.0 dB typ. at $f = 900$ MHz)

Outline

CMPAK-4

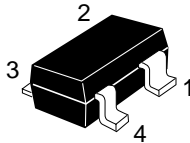

1. Source
2. Gate1
3. Gate2
4. Drain

Absolute Maximum Ratings (Ta = 25°C)

Item	Symbol	Ratings	Unit
Drain to source voltage	V_{DS}	6	V
Gate 1 to source voltage	V_{G1S}	-4	V
Gate 2 to source voltage	V_{G2S}	-4	V
Drain current	I_D	18	mA
Channel power dissipation	Pch	100	mW
Channel temperature	Tch	125	°C
Storage temperature	Tstg	-55 to +125	°C

Electrical Characteristics (Ta = 25°C)

Item	Symbol	Min	Typ	Max	Unit	Test conditions
Gate 1 to cutoff current	I_{G1SS}	—	—	-20	μA	$V_{G1S} = -4$ V $V_{G2S} = V_{DS} = 0$
Gate 2 to cutoff current	I_{G2SS}	—	—	-20	μA	$V_{G2S} = -4$ V $V_{G1S} = V_{DS} = 0$
Gate 1 to source cutoff voltage	$V_{G1S(off)}$	-0.2	—	-1.5	V	$V_{DS} = 3$ V, $V_{G2S} = 0$ $I_D = 100$ μA
Gate 2 to source cutoff voltage	$V_{G2S(off)}$	-0.2	—	-1.5	V	$V_{DS} = 3$ V, $V_{G1S} = 0$ $I_D = 100$ μA
Zero gate voltage drain current	I_{DSS}	25	40	60	mA	$V_{DS} = 3$ V, $V_{G1S} = 0$ $V_{G2S} = 0$
Forward transfer admittance	$ y_{fs} $	30	40	—	mS	$V_{DS} = 3$ V, $V_{G2S} = 0$ $I_D = 5$ mA, $f = 1$ kHz
Power gain	PG	18	21	—	dB	$V_{DS} = 3$ V, $V_{G2S} = 0$
Noise figure	NF	—	1.25	1.5	dB	$I_D = 5$ mA, $f = 900$ MHz
Power gain	PG	—	20	—	dB	$V_{DS} = 1.5$ V, $V_{G2S} = 0$
Noise figure	NF	—	1.3	—	dB	$I_D = 3$ mA, $f = 900$ MHz

Note: Marking is "XV—"

Main Characteristics

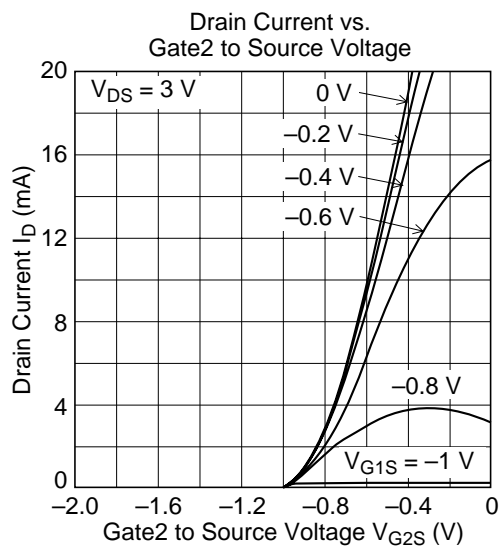
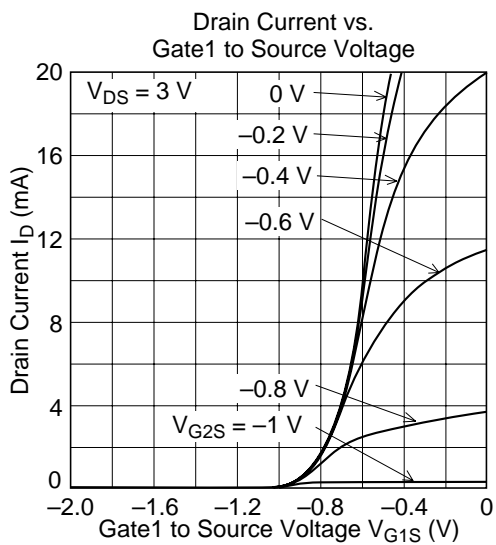
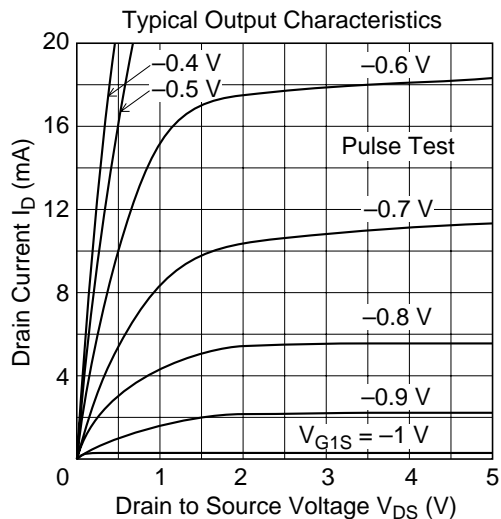
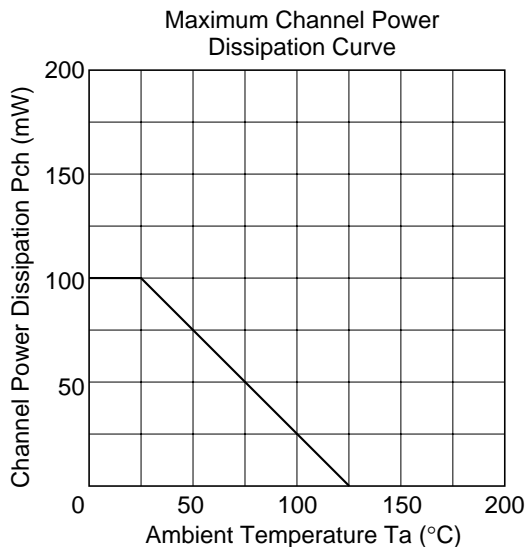

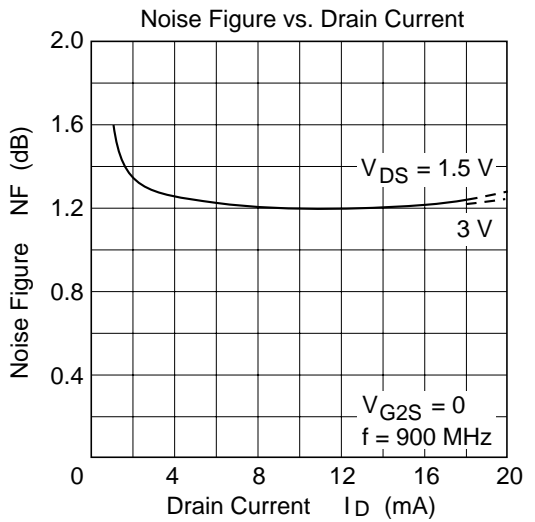
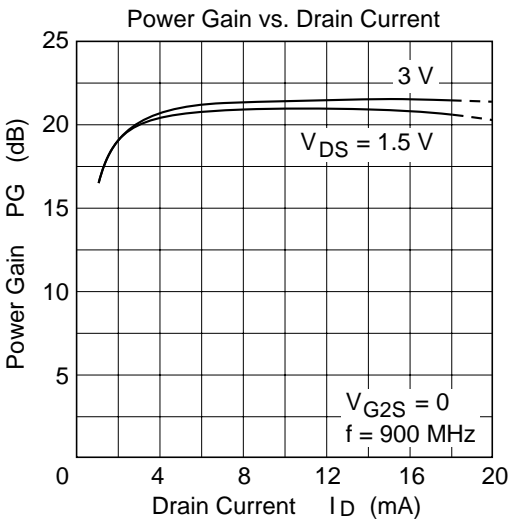
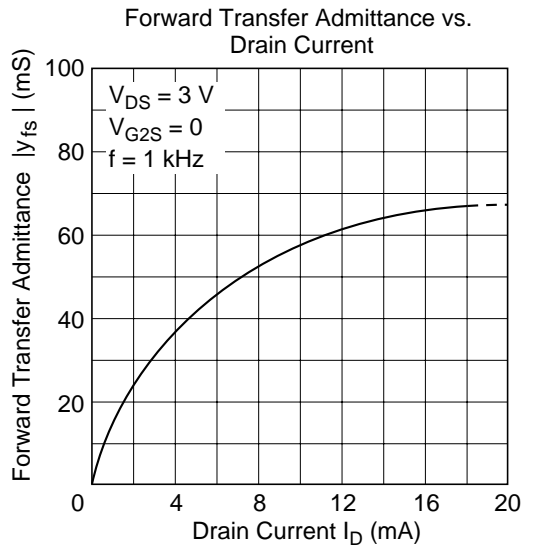
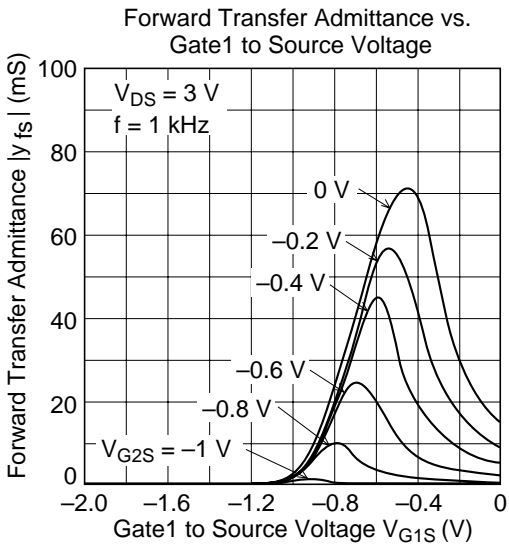

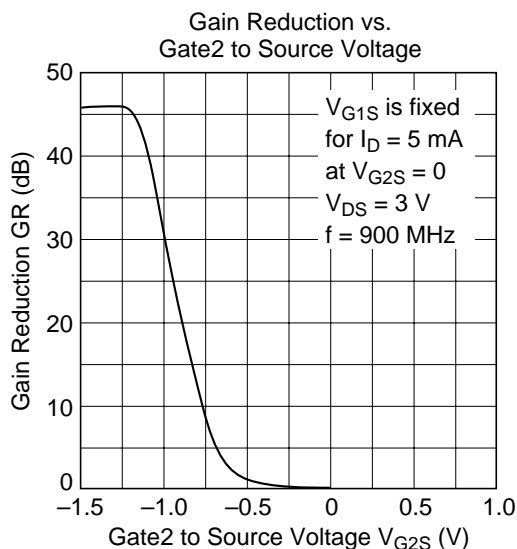
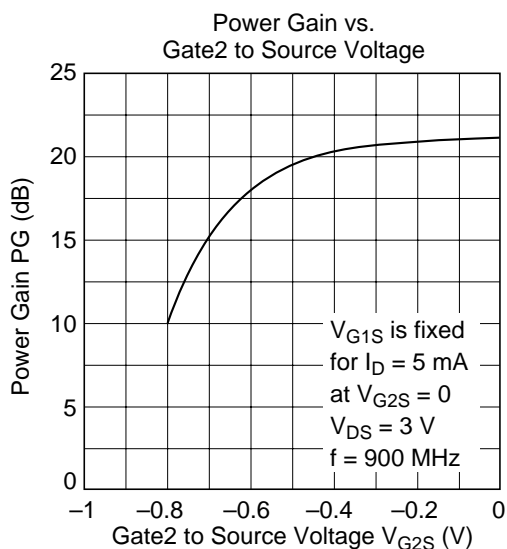
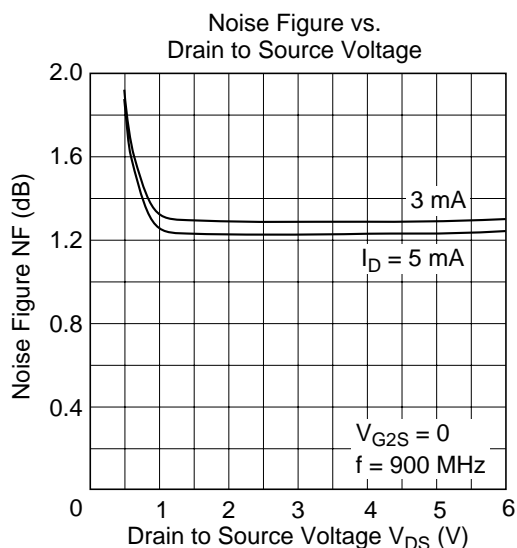
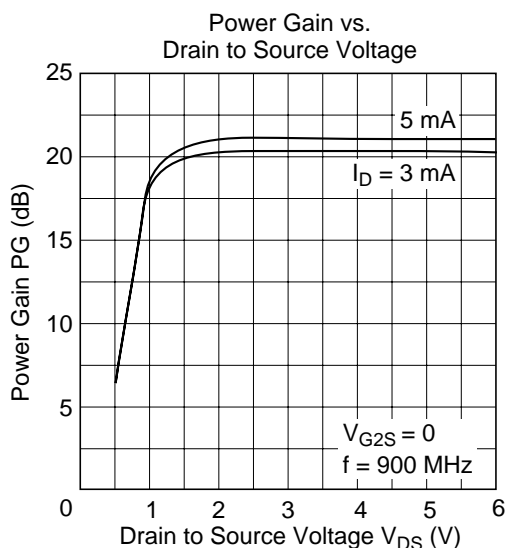

S11 Parameter vs. Frequency

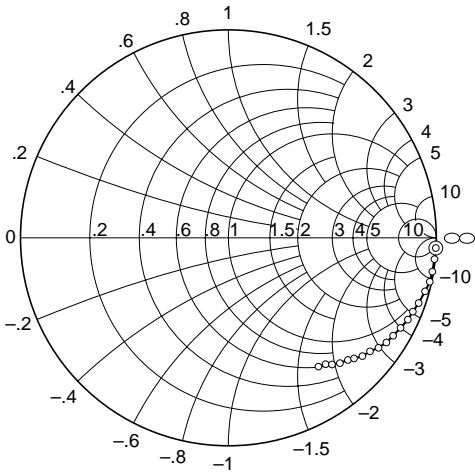

Test Condition: $V_{DS} = 3\text{ V}$, $V_{G2S} = 0\text{ V}$
 $I_D = 5\text{ mA}$, $Z_0 = 50\Omega$
 100 to 2000 MHz (100 MHz step)



S21 Parameter vs. Frequency

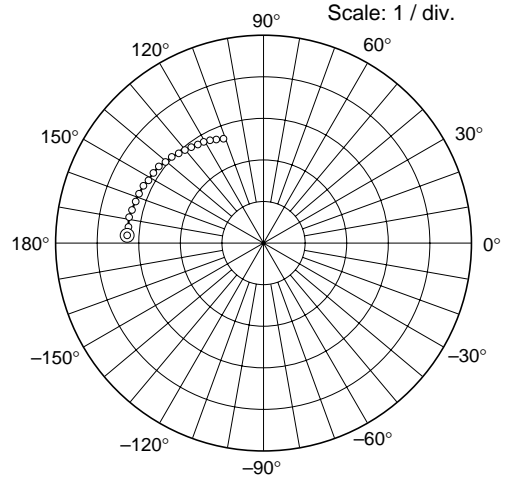

Test Condition: $V_{DS} = 3\text{ V}$, $V_{G2S} = 0\text{ V}$
 $I_D = 5\text{ mA}$, $Z_0 = 50\Omega$
 100 to 2000 MHz (100 MHz step)



S12 Parameter vs. Frequency

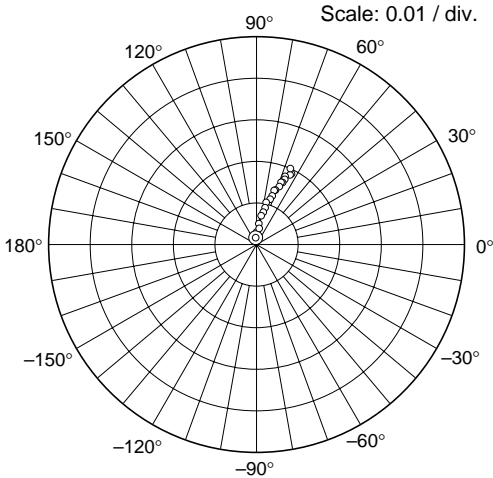

Test Condition: $V_{DS} = 3\text{ V}$, $V_{G2S} = 0\text{ V}$
 $I_D = 5\text{ mA}$, $Z_0 = 50\Omega$
 100 to 2000 MHz (100 MHz step)



S22 Parameter vs. Frequency

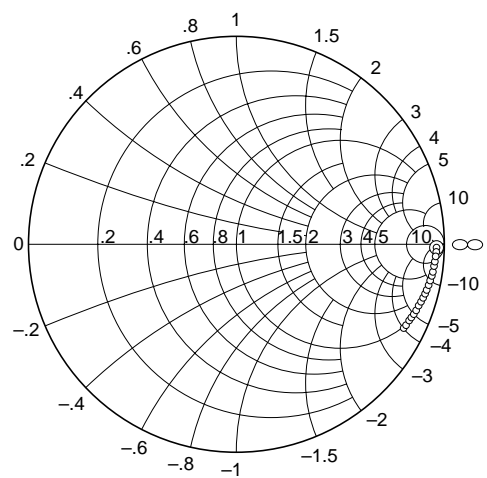

Test Condition: $V_{DS} = 3\text{ V}$, $V_{G2S} = 0\text{ V}$
 $I_D = 5\text{ mA}$, $Z_0 = 50\Omega$
 100 to 2000 MHz (100 MHz step)



Sparameter ($V_{DS} = 3 \text{ V}$, $V_{G2S} = 0$, $I_D = 5 \text{ mA}$, $Z_o = 50 \Omega$)

Freq. (MHz)	S11		S21		S12		S22	
	MAG	ANG	MAG	ANG	MAG	ANG	MAG	ANG
100	0.999	-2.8	3.29	176.7	0.00167	95.2	0.963	-0.9
200	0.997	-5.9	3.27	173.1	0.00302	89.0	0.963	-2.2
300	0.995	-9.4	3.29	169.0	0.00394	80.5	0.961	-3.5
400	0.992	-12.3	3.26	165.8	0.00506	83.7	0.959	-5.0
500	0.981	-15.2	3.23	161.9	0.00703	80.8	0.957	-6.3
600	0.968	-18.9	3.22	158.3	0.00797	78.1	0.955	-8.0
700	0.956	-21.8	3.20	154.4	0.00911	76.9	0.953	-9.2
800	0.949	-24.5	3.15	151.3	0.0104	77.1	0.949	-10.6
900	0.935	-27.6	3.14	147.4	0.0114	73.2	0.946	-12.0
1000	0.922	-30.7	3.12	143.7	0.0123	72.1	0.942	-13.5
1100	0.912	-33.5	3.06	140.3	0.0137	71.9	0.939	-14.7
1200	0.895	-36.2	3.03	136.7	0.0139	70.8	0.935	-16.0
1300	0.873	-38.7	2.97	133.3	0.0150	68.5	0.931	-17.3
1400	0.860	-41.4	2.93	130.1	0.0161	68.5	0.926	-18.6
1500	0.838	-43.8	2.89	126.9	0.0162	67.2	0.922	-20.2
1600	0.822	-45.6	2.85	123.6	0.0171	66.6	0.918	-21.5
1700	0.807	-48.3	2.83	120.5	0.0178	67.2	0.913	-22.7
1800	0.787	-50.7	2.79	117.4	0.0185	66.0	0.909	-23.8
1900	0.767	-52.4	2.74	114.4	0.0186	64.3	0.905	-25.5
2000	0.756	-55.0	2.69	110.9	0.0190	63.7	0.901	-26.6

Power Gain, Noise Figure Test Circuit

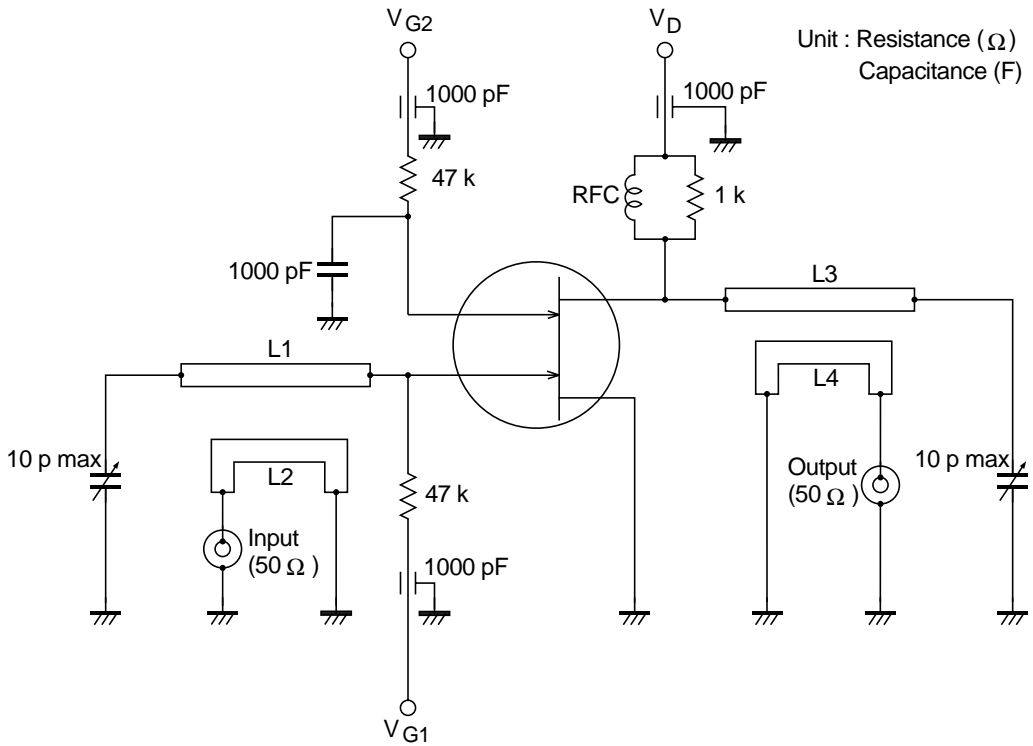

L1 to L4 : ϕ 1 mm copper wire

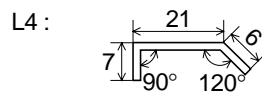
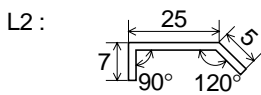
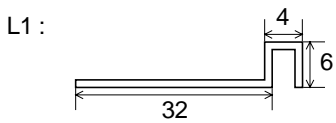

Unit : mm

RFC : 3 turn, 6 mm inside dia (ϕ 1 mm enameled copper wire)

Package Dimentions

Unit: mm

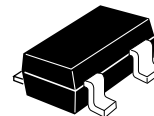
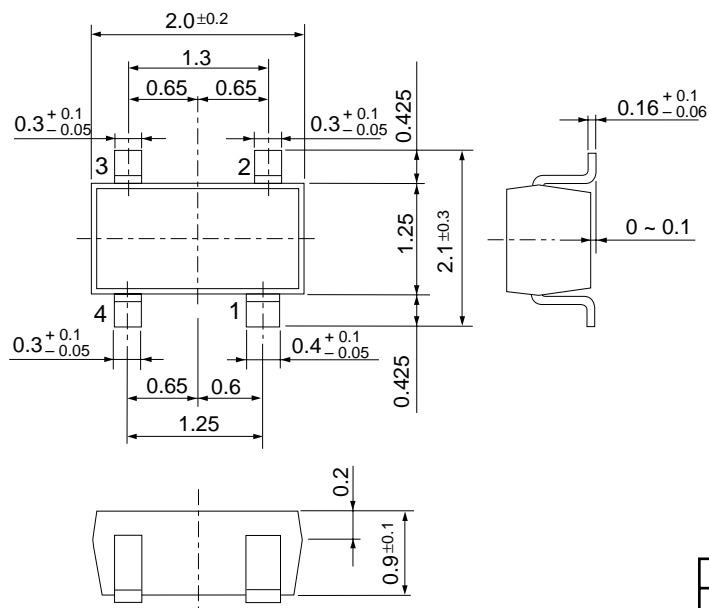

Hitachi code	CMPAK-4
EIAJ	—
JEDEC	—

Datasheet Title

Cautions

1. Hitachi neither warrants nor grants licenses of any rights of Hitachi's or any third party's patent, copyright, trademark, or other intellectual property rights for information contained in this document. Hitachi bears no responsibility for problems that may arise with third party's rights, including intellectual property rights, in connection with use of the information contained in this document.
2. Products and product specifications may be subject to change without notice. Confirm that you have received the latest product standards or specifications before final design, purchase or use.
3. Hitachi makes every attempt to ensure that its products are of high quality and reliability. However, contact Hitachi's sales office before using the product in an application that demands especially high quality and reliability or where its failure or malfunction may directly threaten human life or cause risk of bodily injury, such as aerospace, aeronautics, nuclear power, combustion control, transportation, traffic, safety equipment or medical equipment for life support.
4. Design your application so that the product is used within the ranges guaranteed by Hitachi particularly for maximum rating, operating supply voltage range, heat radiation characteristics, installation conditions and other characteristics. Hitachi bears no responsibility for failure or damage when used beyond the guaranteed ranges. Even within the guaranteed ranges, consider normally foreseeable failure rates or failure modes in semiconductor devices and employ systemic measures such as fail-safes, so that the equipment incorporating Hitachi product does not cause bodily injury, fire or other consequential damage due to operation of the Hitachi product.
5. This product is not designed to be radiation resistant.
6. No one is permitted to reproduce or duplicate, in any form, the whole or part of this document without written approval from Hitachi.
7. Contact Hitachi's sales office for any questions regarding this document or Hitachi semiconductor products.

1. This product must not be placed in the mouth, as it contains toxic substances that may cause poisoning. If by chance the product is placed in the mouth, take emergency action such as inducing vomiting, then consult a physician without delay.
2. Disposal of this product must be handled, separately from other general refuse, by a specialist processing contractor in the same way as dangerous items.

HITACHI

Hitachi, Ltd.

Semiconductor & Integrated Circuits.

Nippon Bldg., 2-6-2, Ohte-machi, Chiyoda-ku, Tokyo 100-0004, Japan

Tel: Tokyo (03) 3270-2111 Fax: (03) 3270-5109

URL NorthAmerica : <http://semiconductor.hitachi.com/>
 Europe : <http://www.hitachi-eu.com/hel/ecg>
 Asia (Singapore) : <http://www.has.hitachi.com.sg/grp3/sicd/index.htm>
 Asia (Taiwan) : http://www.hitachi.com.tw/E/Product/SICD_Frame.htm
 Asia (HongKong) : <http://www.hitachi.com.hk/eng/bo/grp3/index.htm>
 Japan : <http://www.hitachi.co.jp/Sicd/indx.htm>

For further information write to:

Hitachi Semiconductor
(America) Inc.
179 East Tasman Drive,
San Jose, CA 95134
Tel: <1> (408) 433-1990
Fax: <1> (408) 433-0223

Hitachi Europe GmbH
Electronic components Group
Domacher Straße 3
D-85622 Feldkirchen, Munich
Germany
Tel: <49> (89) 9 9180-0
Fax: <49> (89) 9 29 30 00

Hitachi Europe Ltd.
Electronic Components Group.
Whitebrook Park
Lower Cookham Road
Maidenhead
Berkshire SL6 8YA, United Kingdom
Tel: <44> (1628) 585000
Fax: <44> (1628) 778322

Hitachi Asia Pte. Ltd.
16 Collyer Quay #20-00
Hitachi Tower
Singapore 049318
Tel: 535-2100
Fax: 535-1533

Hitachi Asia Ltd.
Taipei Branch Office
3F, Hung Kuo Building, No.167,
Tun-Hwa North Road, Taipei (105)
Tel: <886> (2) 2718-3666
Fax: <886> (2) 2718-8180

Hitachi Asia (Hong Kong) Ltd.
Group III (Electronic Components)
7/F., North Tower, World Finance Centre,
Harbour City, Canton Road, Tsim Sha Tsui,
Kowloon, Hong Kong
Tel: <852> (2) 735 9218
Fax: <852> (2) 730 0281
Telex: 40815 HITEC HX

Copyright © Hitachi, Ltd., 1998. All rights reserved. Printed in Japan.